

Content

1	General informations for disassembling the Modulate Action Pilot (Piston Design)	2
2	Purpose	2
3	Competences	2
4	Scope	2
5	Disclaimer	2
6	Qualified fitting personnel	2
7	Remarks	2
8	Basic safety guidelines	3
9	Disassembly instructions	6

protected

disclosure cat.:	II	proofread:	Cal	published date:	tbd	effect. date:	02/12
author:	AW	released by:	KUW	replaces:	initial	status:	published
resp. depart.:	PP	date of release:	01/31/12	revision No.:	0		
doc. type:	LGS	change rep. No.:		retention period:	10y.		

1 General informations for disassembling the Modulate Action Pilot (Piston Design)

2 Purpose

The documentation describes the disassembly of the modulate action pilot valve (piston design). The description contains every single working step, supplies, tools and appliances.

3 Competences

The generation, maintenance and distribution of the documentation takes place in the organisation department. The defaults will be generated by the technical department in consultation with the final assembly department and production planning department.

4 Scope

This document must be applied to the dismantling of a Pilot Operated Safety Valve in agencies and subsidiaries of LESER GmbH & Co. KG, customers and independent service center.

5 Disclaimer

LESER puts in a great deal of effort into making up-to-date and correct documentation available. Nevertheless, LESER GmbH & Co. KG gives no guarantee that the recommended actions presented here are entirely correct and error free. This document is to be applied exclusively to the specified type. LESER GmbH & Co. KG declines any liability or responsibility for the correctness and completeness of the content.

LESER GmbH & Co. KG reserves the right to change the information contained in this document, which is for the products of LESER GmbH & Co. KG and is intended for LESER subsidiaries, at any time and without prior announcement.

LESER GmbH & Co. KG is available to the users of this document to provide additional information.

6 Qualified fitting personnel

LESER safety valves may only be dismantled by trained or qualified fitters. The qualifications must be obtained through the appropriate training measures.

7 Remarks



Gloves must be worn during the entire dismantling process.

protected

disclosure cat.:	II	proofread:	Cal	published date:	tbd	effect. date:	02/12
author:	AW	released by:	KUW	replaces:	initial	status:	published
resp. depart.:	PP	date of release:	01/31/12	revision No.:	0		
doc. type:	LGS	change rep. No.:		retention period:	10y.		

8 Basic safety guidelines

Dangerous media

Poisoning, caustic burns, burns, injuries

- Use suitable protective devices
- Use suitable collecting tanks.
- Wear suitable protective equipment.

Foreign bodies in the safety valve

Danger from failure of safety valve or leaks

- Flush the system before installation of a safety valve.
- Check the safety valve for foreign objects.
- Remove foreign objects

Bug screen is damaged or missing (B or option)

Dirt, objects or insects get into the safety valve. Danger from malfunction of the safety valve.

- Install the bug screen correctly.
- Check the bug screen regularly.

Ambient temperature is too high

Material expansion. Danger from malfunction of the safety valve.

Ambient temperature is too low

Icing, freezing vapours, reduced flow rate due to congealing media. Danger from functional disruption of the safety valve.

Abrasive or corrosive media

Moving parts jam or become stuck. Danger from functional disruption of the safety valve.

- Service the safety valve after each time it opens.

Media with high proportion of particles (only B)

protected

disclosure cat.:	II	proofread:	Cal	published date:	tbd	effect. date:	02/12
author:	AW	released by:	KUW	replaces:	initial	status:	published
resp. depart.:	PP	date of release:	01/31/12	revision No.:	0		
doc. type:	LGS	change rep. No.:		retention period:	10y.		

Deposits and clogging. Danger from malfunction of the safety valve.

- Use a filter with the correct mesh size.
- Use additional filters to increase the filter capacity.

Residual media in the safety valve

Poisoning, caustic burns, burns, injuries

- Wear suitable protective equipment.
- Remove residual media

WARNING

Leaky safety valve

Danger from leaking media due to damaged gaskets and sealing surfaces.

- Protect the safety valve against vibrations and blows especially during transport and installation.
- Check safety valve regularly for leaks.

Open bonnet or spindle guides

Danger from leaking media

- Make sure that no danger can arise from leaking media.
- Keep a safe distance.
- Wear suitable protective equipment.

CAUTION

Hot medium

Burns or scalding.

- Wear suitable protective equipment.

Hot surfaces

Burns.

- Wear suitable protective equipment.

Aggressive medium

Caustic burns.

- Wear suitable protective equipment.

protected

disclosure cat.:	II	proofread:	Cal	published date:	tbd	effect. date:	02/12
author:	AW	released by:	KUW	replaces:	initial	status:	published
resp. depart.:	PP	date of release:	01/31/12	revision No.:	0		
doc. type:	LGS	change rep. No.:		retention period:	10y.		

Open bonnet or spindle guides

Pinching danger from moving parts.

- Install suitable safeguards.

Sharp edges and burrs

Danger of injury.

- Wear safety gloves.
- Handle the safety valve carefully

High noise emission

Hearing damage.

Wear ear protection.

protected

disclosure cat.:	II	proofread:	Cal	published date:	tbd	effect. date:	02/12
author:	AW	released by:	KUW	replaces:	initial	status:	published
resp. depart.:	PP	date of release:	01/31/12	revision No.:	0		
doc. type:	LGS	change rep. No.:		retention period:	10y.		

9 Disassembly instructions

9.1 Remove the seal

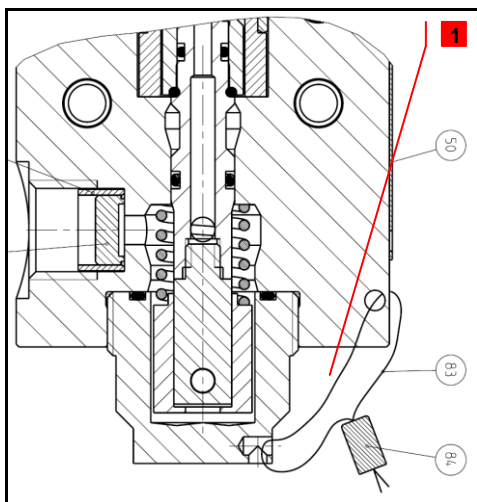
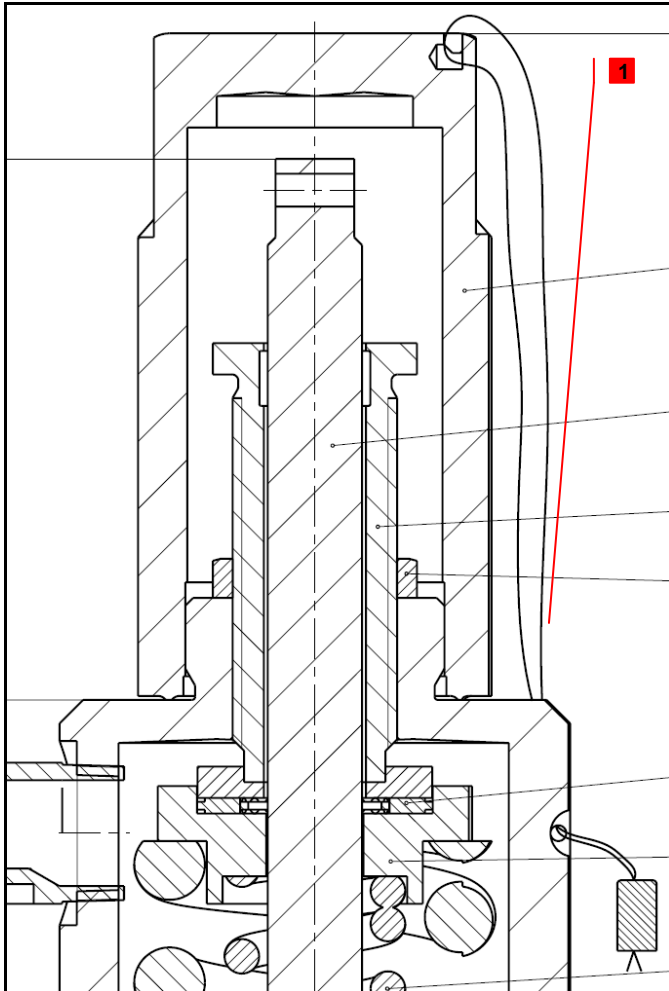

1. Steps – Descriptions

- 1** Cut wire with combination pliers
- 2** Remove seal

protected

2. Supplies

None

3. Tools

Combination pliers

4. Appliance

None

disclosure cat.:	II	proofread:	Cal	published date:	tbd	effect. date:	02/12
author:	AW	released by:	KUW	replaces:	initial	status:	published
resp. depart.:	PP	date of release:	01/31/12	revision No.:	0		
doc. type:	LGS	change rep. No.:		retention period:	10y.		

9.2 Disassembly of the cap and bug-screen

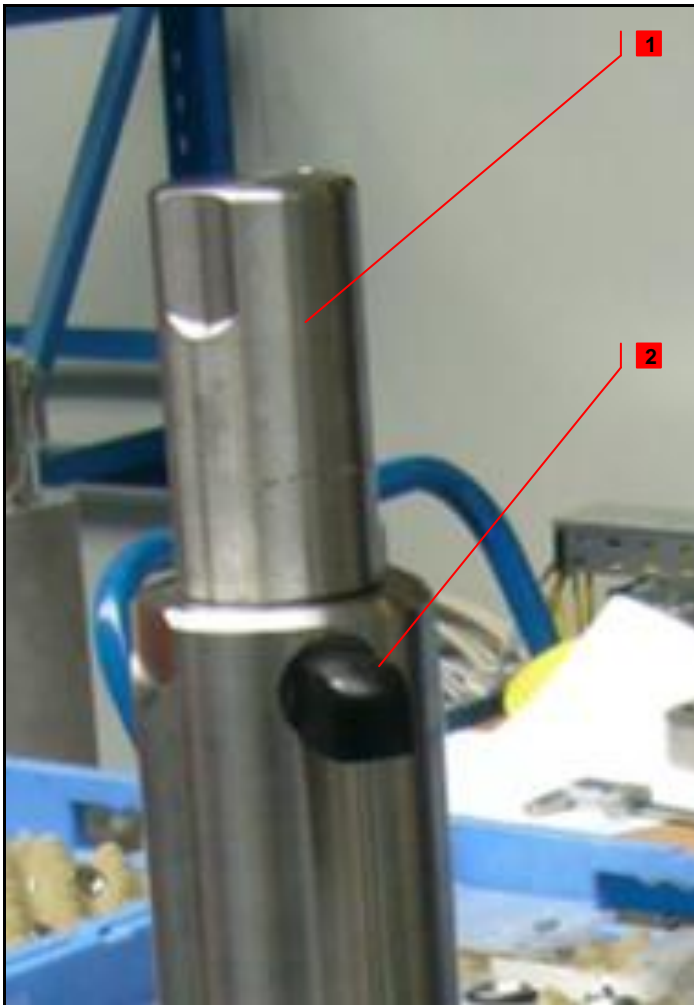

1. Steps – Descriptions

1 Loosen cap [40] with open-end wrench and remove

2 Unscrew and remove bug-screen [64]

Option Test Gag:
Unscrew screw in cap

protected

2. Supplies

None

3. Tools

Open-end wrench acc. to LID

4. Appliance

Test bench

disclosure cat.:	II	proofread:	Cal	published date:	tbd	effect. date:	02/12
author:	AW	released by:	KUW	replaces:	initial	status:	published
resp. depart.:	PP	date of release:	01/31/12	revision No.:	0		
doc. type:	LGS	change rep. No.:		retention period:	10y.		

9.3 Disassembly of the bonnet and spindle unit

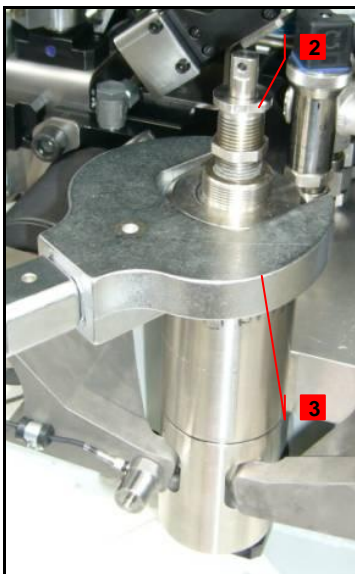
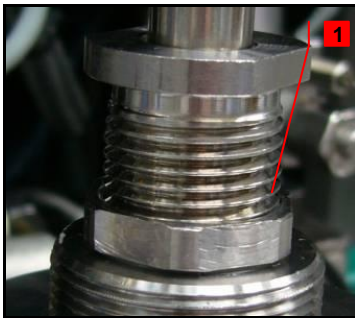

1. Steps – Descriptions

- 1** Loosen lock nut [19] with open-end wrench
- 2** Apply an open-end wrench in a counterclockwise direction on adjusting screw [18] until no more pressure can be felt from spring.
- 3** Loosen bonnet [9] with open-end wrench
- 4** Lift up bonnet [9] along with spindle unit
- 5** Take spindle unit out of bonnet [9]

2. Supplies

None

3. Tools

Open-end wrench acc. to LID

4. Appliance

Test bench

protected

disclosure cat.:	II	proofread:	Cal	published date:	tbd	effect. date:	02/12
author:	AW	released by:	KUW	replaces:	initial	status:	published
resp. depart.:	PP	date of release:	01/31/12	revision No.:	0		
doc. type:	LGS	change rep. No.:		retention period:	10y.		

9.4 Disassembly of the spindle unit

1. Steps – Descriptions

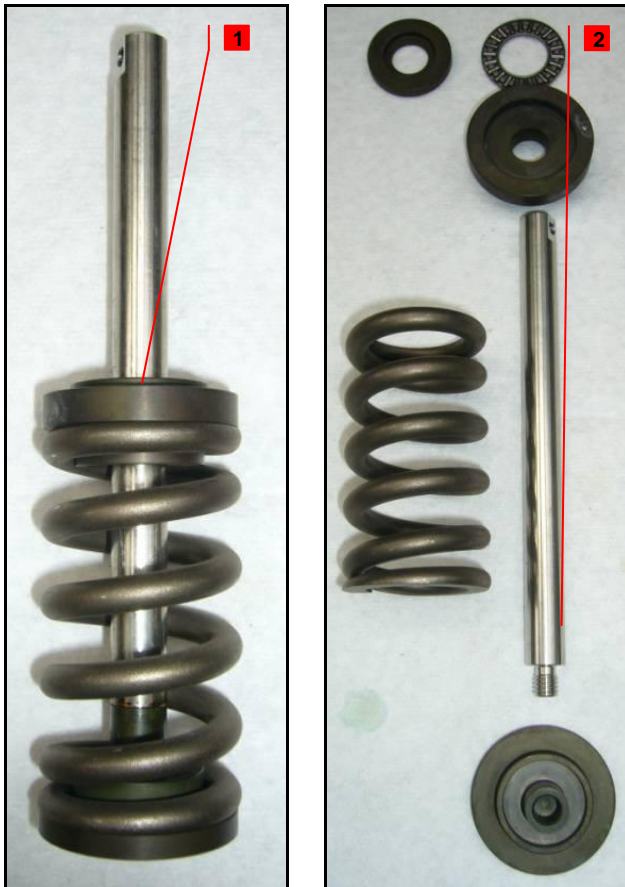

1 Remove successively bushing; bearing [69]; (upper) spring plate [16] and spring [54] of spindle [12]

2 Screw off (lower) spring plate [17] of spindle [12]

protected

2. Supplies

None

3. Tools

Drift pin

4. Appliance

Parallel vice with aluminium jaws

disclosure cat.:	II	proofread:	Cal	published date:	tbd	effect. date:	02/12
author:	AW	released by:	KUW	replaces:	initial	status:	published
resp. depart.:	PP	date of release:	01/31/12	revision No.:	0		
doc. type:	LGS	change rep. No.:		retention period:	10y.		

9.5 Disassembly of the bonnet

1. Steps – Descriptions



1 Loosen lock nut [19] of adjusting screw [18]

2 Screw adjusting screw [18] out of bonnet [9]

3 Completely unscrew lock nut [19] of adjusting screw [18]

protected

2. Supplies

None

3. Tools

None

4. Appliance

None

disclosure cat.:	II	proofread:	Cal	published date:	tbd	effect. date:	02/12
author:	AW	released by:	KUW	replaces:	initial	status:	published
resp. depart.:	PP	date of release:	01/31/12	revision No.:	0		
doc. type:	LGS	change rep. No.:		retention period:	10y.		

9.6 Disassembly of the body's bottom side

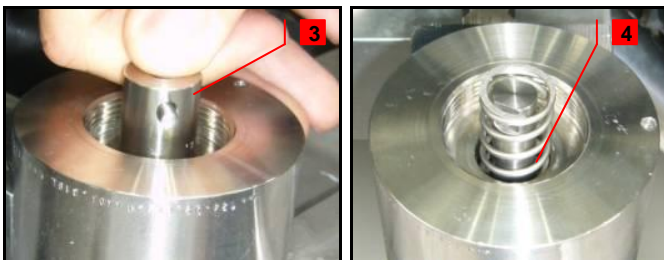
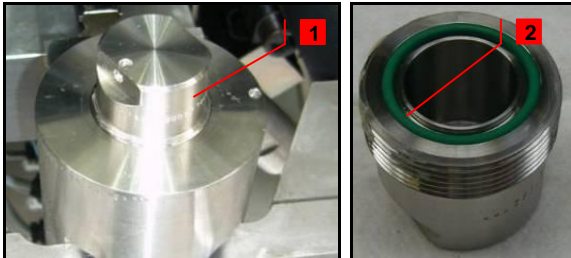

1. Steps – Descriptions

- 1** Loosen plug [20] with open-end wrench and screw off
- 2** Take out O-ring
- 3** Remove parallel pin [44] with drift pin
- 4** Remove coupling [43] and return spring [42] by lifting them upwards

2. Supplies

None

3. Tools

Open-end wrench acc. to LID
Hook tool for O-rings
Drift pin

4. Appliance

Test bench

protected

disclosure cat.:	II	proofread:	Cal	published date:	tbd	effect. date:	02/12
author:	AW	released by:	KUW	replaces:	initial	status:	published
resp. depart.:	PP	date of release:	01/31/12	revision No.:	0		
doc. type:	LGS	change rep. No.:		retention period:	10y.		

9.7 Disassembly of the piston unit and body

1. Steps – Descriptions



1 Pull piston unit out of body [1]

protected

2. Supplies

None

3. Tools

None

4. Appliance

Test bench

disclosure cat.:	II	proofread:	Cal	published date:	tbd	effect. date:	02/12
author:	AW	released by:	KUW	replaces:	initial	status:	published
resp. depart.:	PP	date of release:	01/31/12	revision No.:	0		
doc. type:	LGS	change rep. No.:		retention period:	10y.		

9.8 Disassembly of the guide bush and piston upper

1. Steps – Descriptions

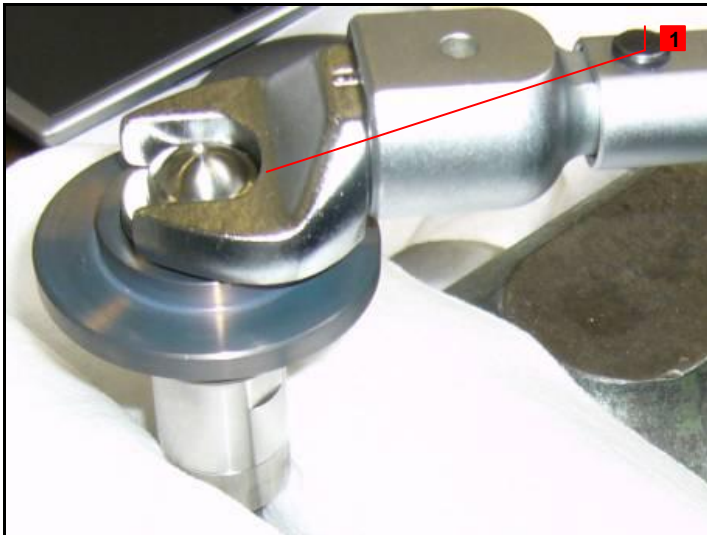

Place unit in parallel vice with aluminium jaws

- 1** Unscrew piston, upper [47]
- 2** Pull guide bush [2] off piston [41]

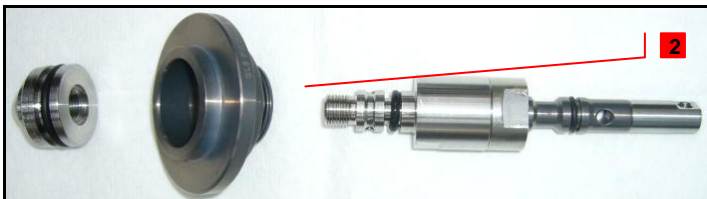

2. Supplies

None

3. Tools

Open-end wrench acc. to LID

4. Appliance

Parallel vice with aluminium jaws
Assembling aid

protected

disclosure cat.:	II	proofread:	Cal	published date:	tbd	effect. date:	02/12
author:	AW	released by:	KUW	replaces:	initial	status:	published
resp. depart.:	PP	date of release:	01/31/12	revision No.:	0		
doc. type:	LGS	change rep. No.:		retention period:	10y.		

9.9 Disassembly of the piston and feeding seat unit

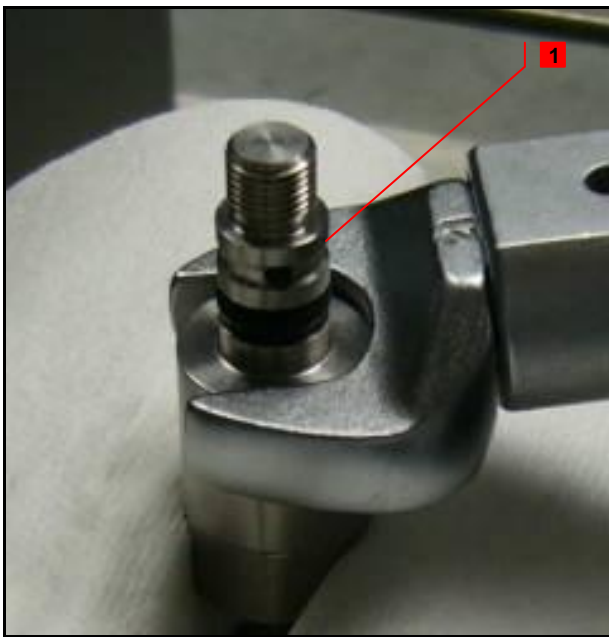

1. Steps – Descriptions

Place piston unit in parallel vice with aluminium jaws

1 Loosen and remove piston [41] with open-end wrench

protected

2. Supplies

None

3. Tools

Open-end wrench acc. to LID

4. Appliance

Parallel vice with aluminium jaws

disclosure cat.:	II	proofread:	Cal	published date:	tbd	effect. date:	02/12
author:	AW	released by:	KUW	replaces:	initial	status:	published
resp. depart.:	PP	date of release:	01/31/12	revision No.:	0		
doc. type:	LGS	change rep. No.:		retention period:	10y.		

9.10 Removing the O-rings

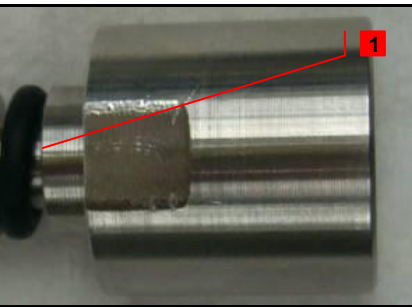
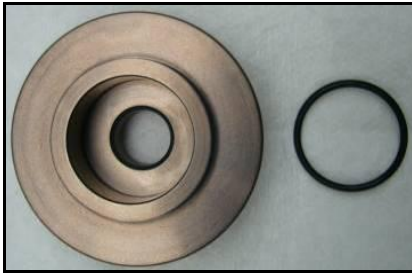

1. Steps – Descriptions

1 Remove O-rings

2. Supplies

None

3. Tools

Hook tool for O-rings

4. Appliance

None

protected

disclosure cat.:	II	proofread:	Cal	published date:	tbd	effect. date:	02/12
author:	AW	released by:	KUW	replaces:	initial	status:	published
resp. depart.:	PP	date of release:	01/31/12	revision No.:	0		
doc. type:	LGS	change rep. No.:		retention period:	10y.		

9.11 Disassembly of the feeding seat unit

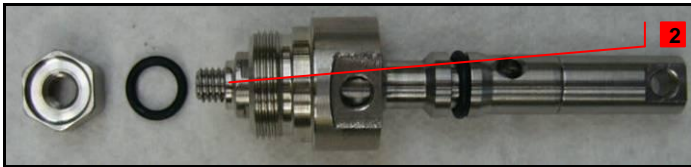

1. Steps – Descriptions

- 1** Loosen and unscrew (upper) disc feeding [7] of (lower) disc exhaust [11]
- 2** Remove O-ring
- 3** Pull (lower) disc feeding [8] and seat feeding [5] off (lower) disc exhaust [11]
- 5** Remove O-rings off (lower) disc exhaust [11]
- 6** Unscrew (lower) disc exhaust [11] and (lower) disc exhaust extension [45]

2. Supplies

None

3. Tools

Hook tool for O-rings
Drift pin
Open-end wrench acc. to LID

4. Appliance

None

protected

disclosure cat.:	II	proofread:	Cal	published date:	tbd	effect. date:	02/12
author:	AW	released by:	KUW	replaces:	initial	status:	published
resp. depart.:	PP	date of release:	01/31/12	revision No.:	0		
doc. type:	LGS	change rep. No.:		retention period:	10y.		

9.12 Disassembly of the manifold block

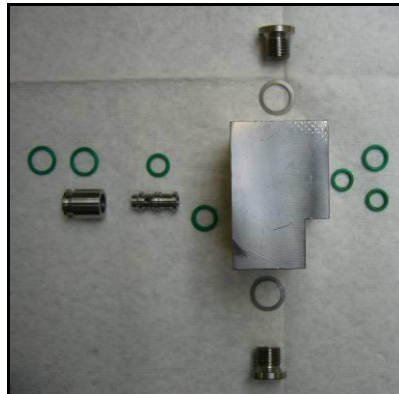
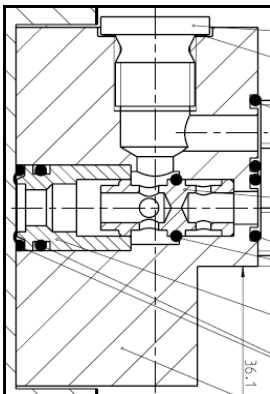
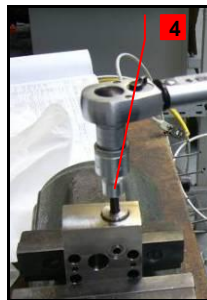
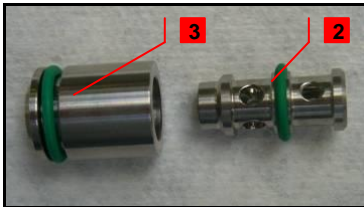
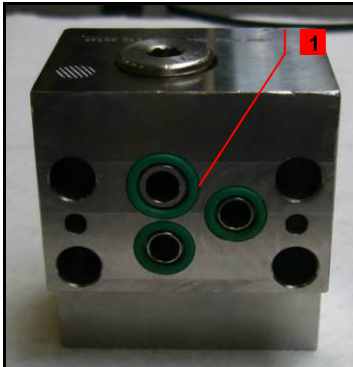

1. Steps – Descriptions

- 1** Remove piston [24.3] bushing [24.4] and O-rings
- 2** Remove O-rings of piston [24.3]
- 3** Remove O-rings of bushing [24.4]
- 4** Screw off lock screw [24.7] and remove gasket [24.8]

protected

2. Supplies

None

3. Tools

Allen key acc. to LID
Hook tool for O-rings

4. Appliance

Parallel vice with aluminium jaws
Test bench

disclosure cat.:	II	proofread:	Cal	published date:	tbd	effect. date:	02/12
author:	AW	released by:	KUW	replaces:	initial	status:	published
resp. depart.:	PP	date of release:	01/31/12	revision No.:	0		
doc. type:	LGS	change rep. No.:		retention period:	10y.		